

CHAPTER 5

STEADY STATE ANALYSIS AND SIMULATION OF THE IPM GENERATOR FEEDING A RECTIFIER-BUCK-RESISTIVE LOAD

5.1 Introduction

In this chapter, the steady state analysis and simulation of the IPM generator feeding a rectifier-buck resistive load will be presented. The first part of the chapter concerns itself with developing mathematical equations which describe the switching functions of the buck converter for steady state. An equivalent resistance which is dependent upon the actual load resistance and the duty cycle of the converter will be obtained. In addition, various plots showing how an ideal voltage source system feeding a buck system behaves will be generated. The graphs are useful in conceptualizing how the buck converter works.

Next, using the mathematical model developed, the steady state experimental results will be compared with the predicted results. The method used to model the transistor and the control signal to turn it on and off will be presented and a comparison between the measured and simulated waveforms will be given.

The normal goal of dc-dc converters is to maintain a desired output voltage at a desired level, even though the input voltage and the output load may vary. Figure 5.1 shows a simple example of a dc-dc converter where the average output voltage is controlled by the switch on and off times (DT and $(1-D)T$). D is the duty ratio (cycle) and is defined as the ratio of the on- duration to the total switching time period T .

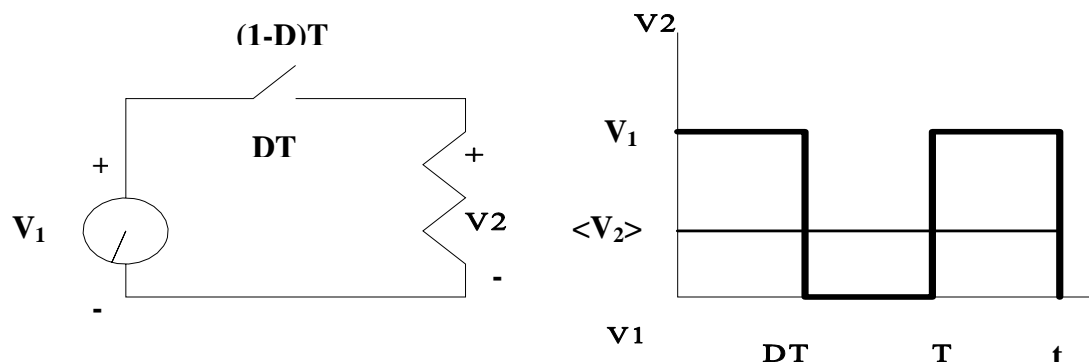

Figure 5.1. Basic dc-dc converter and associated voltage output

If the switch is always on, it is easy to see that the average output voltage will equal the input voltage; however, as the percentage of time that the switch is off increases, the average output voltage will decrease and will obviously become equal to zero when the switch is always off. The scheme thus far described is a buck converter (which has the ability to regulate the output voltage from a maximum value equal to the supply voltage to a minimum value equal to zero volts); however, it can be seen that while one is able to control the average value of the output voltage, the instantaneous voltage fluctuates between zero and V_1 . This fluctuation is not acceptable in most of the applications where a regulated dc supply voltage is required.

The problem of output voltage fluctuation is largely solved by using a low pass filter consisting of a series inductor and a parallel capacitor. Figure 5.2 shows the schematic of the basic dc-dc converter with the low pass filter in place. It can also be seen that a diode

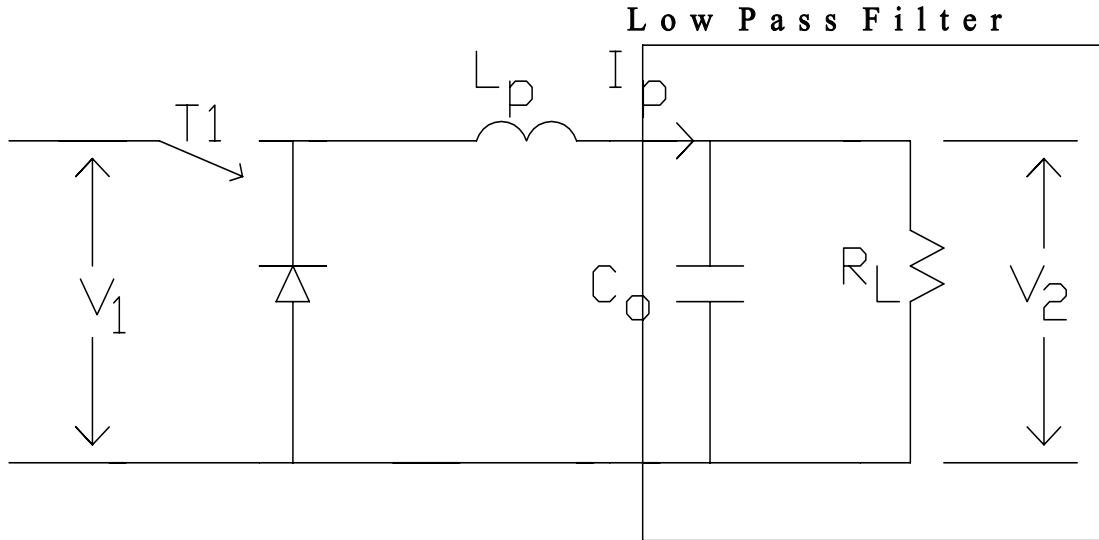

Figure 5.2. Dc-dc (buck) converter with low pass filter

has also been included in the circuit. Its presence is primarily needed to prevent the switch (transistor) from having to dissipate or absorb inductive energy (which would destroy it).

The low pass filter components are chosen so that the corner frequency is much lower than the switching frequency of the switch itself. When this is done, the output voltage fluctuation is virtually eliminated and for most analyses, the output voltage can be assumed to be a constant dc voltage [34].

Thus far, the way in which the switch is turned on and off has not been discussed. The regulation of the output voltage is achieved via a pulse width modulator which controls how long a switch is on and off. Figure 5.3 shows a saw tooth voltage and dc control voltage plotted vs time. When the dc voltage is larger than the saw tooth voltage, the switch is turned on, and when the voltage becomes smaller than the

sawtooth voltage, the switch is turned off. If the dc-dc converter is to have closed loop feedback, then the output voltage would be monitored and compared with a desired output voltage (see Figure 5.4). The difference between the actual and the desired output voltage will regulate the magnitude of the dc control signal and will thus control the duty ratio of the system.

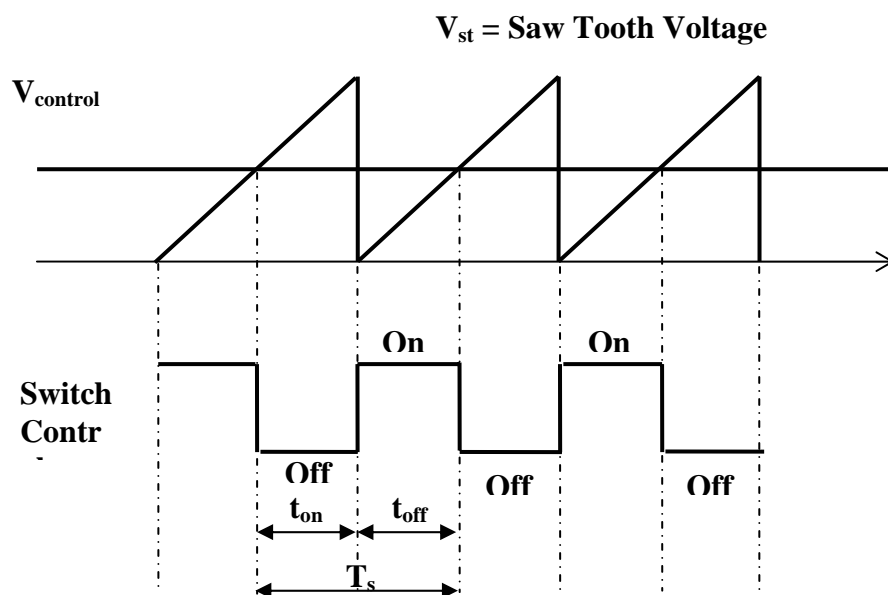

Figure 5.3. Control signal and sawtooth voltage waveforms and switching signal sent to turn switch on and off

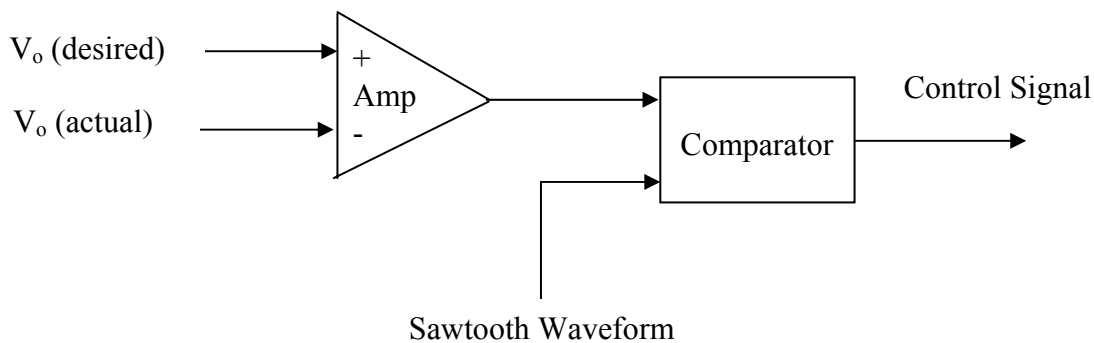

Figure 5.4. Schematic diagram of comparators and op-amp used to control signal of a converter

5.2 Derivation of a Buck Converter Operating in Steady State

The derivation for the steady state equivalent circuit of a buck converter builds upon the result found for the equivalent circuit which represents the rectifier feeding a resistive load. Figure 5.5 shows the current flowing through the inductor L_p (see Figure 5.6) along with the switching functions associated with the three modes of operation for the buck converter. The first mode is when the transistor T1 is on, the second is when T1 is off and the current flowing through the inductor L_p is greater than zero, and the third mode is when the transistor T1 is off and the current flowing through the inductor L_p is zero.

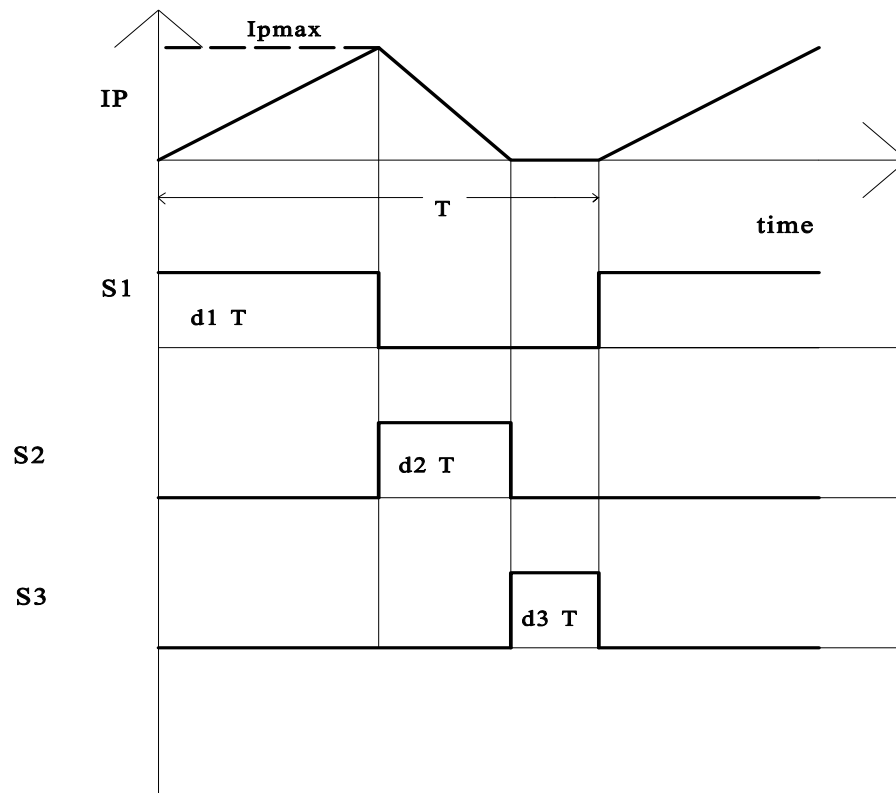

Figure 5.5. Inductor current and switching functions for the buck converter

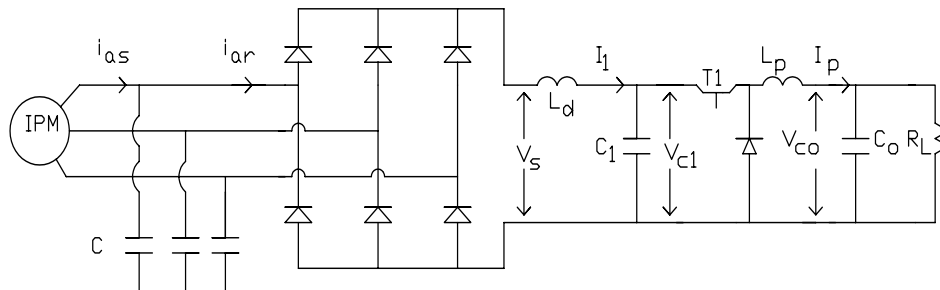

Figure 5.6. Schematic diagram of an IPM generator feeding a rectifier-buck-resistive load

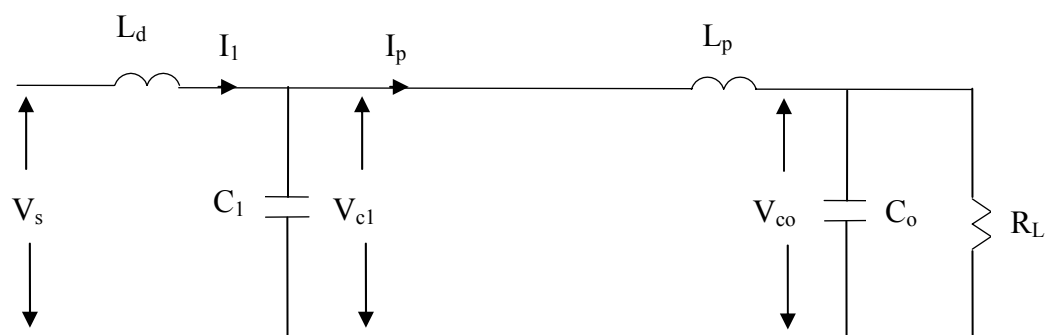

Figure 5.7 Buck converter in mode 1 operation

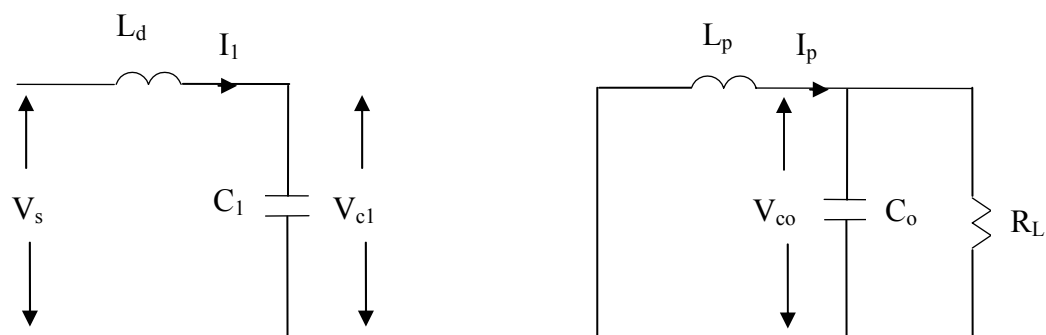

Figure 5.8. Buck converter in modes 2 and 3

Before beginning the derivation for the buck converter, the mathematical basis for the fundamental approximation in the state-space averaging approach will be given. The derivation is taken from [35].

Let two linear systems described by

(i) Interval Td_1 , $0 < t < t_0$:

$$\dot{x} = A_1 x, \quad (5.1)$$

(ii) Interval Td_2 , $t_0 < t < T$:

$$\dot{x} = A_2 x. \quad (5.2)$$

The exact solution of the state-space equations are

$$\begin{aligned} x(t) &= e^{A_1 t} x(0) & t \in [0, t_0] \\ x(t) &= e^{A_2(t-t_0)} x(t_0) & t \in [t_0, T]. \end{aligned} \quad (5.3)$$

Across the switching instant t_0 the state-variable vector $x(t)$ is continuous, and,

$$x(T) = e^{A_2(T-Td_1)} x(t_0) = e^{d_2 A_2 T} e^{d_1 A_1 T} x(0). \quad (5.4)$$

therefore

A linear approximation of the solution of the system can be accomplished by using the Baker-Campbell-Hausdorff series

$$AT = (d_1 A_1 + d_2 A_2)T + d_1 d_2 (A_1 A_2 - A_2 A_1)T^2, \quad (5.5)$$

where

$$e^{AT} = e^{d_2 A_2 T} e^{d_1 A_1 T} .$$

The first approximation solutions are

$$\begin{aligned} e^{d_1 A_1 T} &\approx I + d_1 A_1 T \\ e^{d_2 A_2 T} &\approx I + d_2 A_2 T , \end{aligned} \tag{5.6}$$

where I is the identity matrix.

Therefore,

$$e^{d_2 A_2 T} e^{d_1 A_1 T} \approx e^{(d_1 A_1 + d_2 A_2) T} , \tag{5.7}$$

which results in the approximate solution

$$x(T) \approx e^{(d_1 A_1 + d_2 A_2) T} x(0) . \tag{5.8}$$

This is the same as the solution of the following linear system equation for x(T):

$$\dot{x} = (d_1 A_1 + d_2 A_2) x . \tag{5.9}$$

This equation is the averaged model obtained from the switched models given in Equations (5.1) and (5.2) .

The differential equations for each mode of the buck converter are:

Mode 1: S₁ T1 ON 0 ≤ t ≤ d₁T

For mode 1, shown in Figure 5.7, the systems equations can be written as

$$\begin{aligned}
 L_d \frac{dI_l}{dt} &= V_s - V_c I \\
 C_l \frac{dV_c I}{dt} &= I_l - I_p \\
 L_p \frac{dI_p}{dt} &= V_c I - V_{co} \\
 C_o \frac{dV_{co}}{dt} &= I_p - \frac{V_{co}}{R_L} .
 \end{aligned} \tag{5.10}$$

Equation (5.10) can be written in matrix representation as

$$\frac{dx}{dt} = [A_l] x + [B_l] u , \tag{5.11}$$

where

$$x = \begin{bmatrix} I_l \\ V_c I \\ I_p \\ V_{co} \end{bmatrix}, A_l = \begin{bmatrix} 0 & -\frac{1}{L_d} & 0 & 0 \\ \frac{1}{C} & -\frac{1}{C_l} & 0 & 0 \\ 0 & \frac{1}{L_p} & 0 & -\frac{1}{L_p} \\ 0 & 0 & \frac{1}{C_o} & -\frac{1}{C_o R_L} \end{bmatrix}, B_l = \begin{bmatrix} \frac{1}{L_d} \\ 0 \\ 0 \\ 0 \end{bmatrix}, u = [V_s] .$$

Mode 2: S₂ T1 OFF (I_p > 0) d₁T ≤ t ≤ d₂T

For mode 2, shown in Figure 5.8, the systems equations can be written as

$$\begin{aligned}
 L_d \frac{dI_1}{dt} &= V_s - V_c I \\
 C_1 \frac{dV_c I}{dt} &= I_1 \\
 L_p \frac{dI_p}{dt} &= -V_{co} \\
 C_o \frac{dV_{co}}{dt} &= I_p - \frac{V_{co}}{R_L} .
 \end{aligned} \tag{5.12}$$

For mode 2, shown in Figure 5.8, the systems equations can be written as

$$\frac{dx}{dt} = [A_2] x + [B_2] u , \tag{5.13}$$

where

$$x = \begin{bmatrix} I_1 \\ V_c I \\ I_p \\ V_{co} \end{bmatrix}, A_2 = \begin{bmatrix} 0 & -\frac{1}{L_d} & 0 & 0 \\ \frac{1}{C_1} & 0 & 0 & 0 \\ 0 & 0 & 0 & -\frac{1}{L_p} \\ 0 & 0 & \frac{1}{C_o} & -\frac{1}{C_o R_L} \end{bmatrix}, B_2 = \begin{bmatrix} \frac{1}{L_d} \\ 0 \\ 0 \\ 0 \end{bmatrix}, u = [V_s] .$$

Mode 3: S₃ T1 OFF (I_p =0) (d₁ + d₂)T ≤ t ≤ (d₁ + d₂ + d₃)T

For mode 3, (shown in Figure 5.8) with the understanding that the current in the inductor L_p = 0, the systems equations can be written as

$$\begin{aligned}
 L_d \frac{dI_1}{dt} &= V_s - V_c I \\
 C_1 \frac{dV_c I}{dt} &= I_1 \\
 L_p \frac{dI_p}{dt} &= 0 \\
 C_o \frac{dV_{co}}{dt} &= -\frac{V_{co}}{R_L} .
 \end{aligned} \tag{5.14}$$

The same differential equations written in matrix representation are

$$\frac{dx}{dt} = [A_3] x + [B_3] u , \tag{5.15}$$

where

$$x = \begin{bmatrix} I_1 \\ V_c I \\ I_p \\ V_{co} \end{bmatrix}, A_3 = \begin{bmatrix} 0 & -\frac{1}{L_d} & 0 & 0 \\ \frac{1}{C_1} & 0 & 0 & 0 \\ 0 & 0 & 0 & 0 \\ 0 & 0 & 0 & -\frac{1}{C_o R_L} \end{bmatrix}, B_3 = \begin{bmatrix} \frac{1}{L_d} \\ 0 \\ 0 \\ 0 \end{bmatrix}, u = [V_s] .$$

Now, using the result of Equation (5.9) , it is possible to obtain the single vector equation

$$\frac{dx}{dt} = A x + B u , \quad (5.16)$$

where

$$A = A_1 S_1 + A_2 S_2 + A_3 S_3 \quad B = B_1 S_1 + B_2 S_2 + B_3 S_3 .$$

Supposing that the quantities x , u , S_1 , S_2 , S_3 , and u vary around their respective steady state values, then the following substitutions may be made

$$\begin{aligned} S_1 &= s_1 + \tilde{s}_1 \\ S_2 &= s_2 + \tilde{s}_2 \\ S_3 &= s_3 + \tilde{s}_3 \\ u &= u + \tilde{u} \\ x &= X + \tilde{x} \\ \frac{dx}{dt} &= \frac{\tilde{dx}}{dt} . \end{aligned} \quad (5.17)$$

Under these conditions, Equation (5.16) becomes

$$\begin{aligned} \frac{\tilde{dx}}{dt} = & [A_1 s_1 + A_2 s_2 + A_3 s_3] X + [B_1 s_1 + B_2 s_2 + B_3 s_3] u \\ & + [A_1 s_1 + A_2 s_2 + A_3 s_3] \tilde{x} + [B_1 s_1 + B_2 s_2 + B_3 s_3] \tilde{u} \\ & + [A_1 \tilde{s}_1 + A_2 \tilde{s}_2 + A_3 \tilde{s}_3] x + [B_1 \tilde{s}_1 + B_2 \tilde{s}_2 + B_3 \tilde{s}_3] u \\ & + [\dots] \tilde{s} \tilde{u} . \end{aligned} \quad (5.17)$$

The last term can be ignored if the changes (perturbations) are much smaller than the corresponding steady-state values. The steady state waveforms can now be separated into dc

and ac components. Of interest here is the dc component which is given as

$$[A_1 s_1 + A_2 s_2 + A_3 s_3] X + [B_1 s_1 + B_2 s_2 + B_3 s_3] u = 0 .$$

The dc (average value) of the switching functions are

$$\begin{aligned} s_1 &= \frac{d_1 T}{T} = d_1 \\ s_2 &= \frac{d_2 T}{T} = d_2 \\ s_3 &= \frac{d_3 T}{T} = d_3 , \end{aligned} \tag{5.19}$$

and, recognizing that

$$d_1 + d_2 + d_3 = 1 , \tag{5.20}$$

then d_3 may be written as

$$d_3 = 1 - d_1 - d_2 . \tag{5.21}$$

Substituting Equation (5.21) into (5.18) and rearranging gives

$$\begin{aligned}
 V_s &= V_c I \\
 I_1 &= d_1 I_p \\
 V_c I &= \frac{(d_1 + d_2)}{d_1} V_{co} \\
 \frac{V_{co}}{R_L} &= (d_1 + d_2) I_p \cdot
 \end{aligned} \tag{5.22}$$

The effective input resistance is defined as the input voltage over the input current, i.e.

$$R_{eff} = \frac{V_s}{I_1} \cdot \tag{5.23}$$

In terms of the duty cycle and the load resistance R_L the effective resistance can be found as follows:

$$R_{eff} = \frac{V_s}{I_1} = \frac{V_s}{d_1 I_p} = \frac{d_1 + d_2}{d_1} R_L I_p (d_1 + d_2) \left(\frac{I}{d_1 I_p} \right) = \frac{(d_1 + d_2)^2}{d_1^2} R_L \cdot \tag{5.24}$$

In terms of d_1 and d_3 , Equation_(5.24) may be written as

$$R_{eff} = \frac{(1 - d_3)^2}{d_1^2} R_L \cdot \tag{5.25}$$

Referring to Figure 5.5, and assuming that the converter is operating in discontinuous conduction mode (meaning that the current in the inductor becomes zero for a time) then,

when the buck converter is operating in mode one, the current $i_p(t)$ rises linearly from a zero value at the beginning of the mode to a maximum value at time $t=d_1T$ of

$$I_{pmax} = \frac{(V_c I - V_{co}) d_1 T}{L_p} . \quad (5.26)$$

The converter will then switch into mode two operation and the current will fall linearly from I_{pmax} to a zero value at a time $t=(d_1 + d_2)T$. The average value of the inductor current I_p over a complete cycle may be found by taking the area under the two triangles, and dividing by the total time T . Thus,

$$I_p = I_{pmax} \frac{(d_1 T + d_2 T)}{2 T} = (V_c I - V_{co}) d_1 T \frac{(d_1 + d_2)}{2 L_p} . \quad (5.27)$$

At steady state, the average current in the capacitor C_0 is zero. Since this is true, then the average current going into the load resistance R_L must equal the average current in the inductor L_p . Thus,

$$I_L = \frac{V_{co}}{R_L} = (V_c I - V_{co}) d_1 T \frac{(d_1 + d_2)}{2 L_p} , \quad (5.28)$$

or

$$V_{co} = R_L (V_c I - V_{co}) d_1 T \frac{(d_1 + d_2)}{2 L_p} . \quad (5.29)$$

Substituting the value of V_{c1} in Equation (5.22) gives

$$V_{co} = R_L V_{co} \left(\frac{d_1 + d_2}{d_1} - 1 \right) d_1 T \frac{(d_1 + d_2)}{2 L_p}, \quad (5.30)$$

which, after simplification yields

$$d_1^2 d_2 + d_2^2 - \frac{2 L_p}{R_L} T = 0. \quad (5.31-a)$$

In terms of d_1 and d_3 this equation becomes

$$d_3^2 + d_3(d_1 - 2) + (1 - d_1^2 - 2 d_1 - \frac{2 L_p}{T R_L}) = 0. \quad (5.31-b)$$

Therefore, knowing the duty cycle d_1 , the total period T , the load resistance R_L , and the value of the inductor L_p , the percentage of time that the converter is operating in discontinuous conduction mode may be determined by solving Equation (5.31-b) for d_3 . If the solution for d_3 is either zero or negative, then the converter is always in continuous conduction mode.

For a given load resistance and period, the converter will tend toward discontinuous conduction mode as both d_1 and L_p are decreased. At the boundary condition between continuous and discontinuous conduction mode, $d_3=0$, and Equation (5.31-b) may be written as

$$1 - d_1^2 - 2 d_1 = \frac{2 L_p}{T R_L} . \quad (5.32)$$

It can be seen that, as the duty cycle d_1 is decreased, the inductor value must be increased to satisfy the equation. As d_1 tends toward zero then the equation may be approximated as

$$1 = \frac{2 L_p}{T R_L} . \quad (5.33)$$

Solving for L_p gives

$$L_p = T \frac{R_L}{2} .$$

Thus, if one wants to be sure of operating in continuous mode (which is normally the case because of the high stresses placed on the transistors when operating in discontinuous mode) regardless of the duty cycle, then a good rule of thumb to ensure this is to choose an inductor value such that

$$L_p > T \frac{R_L}{2} . \quad (5.35)$$

For the steady state analysis in this thesis, only the continuous conduction mode was considered. With that being the case, d_3 of Equation (5.25) is zero and the effective

resistance for the buck may be written as

$$R_{effbk} = \frac{R_L}{d_1^2}. \quad (5.36)$$

The equivalent resistance given in Equation (5.36) may be substituted into Equation (4.31) to obtain the equivalent resistance of the buck-rectifier system. After the substitution, the equivalent resistance that the IPM (or any other power source) sees at its terminals is given in Equation (5.37) and will be used to predict the performance of the IPM feeding a rectifier-buck-resistance load.

$$R_{effbkrec} = \frac{R_L \pi^2}{12 d_1^2} \quad (5.37)$$

5.2.1 Examination of Ideal Buck Converter

In order to gain an appreciation of the significance of Equation 5.36, various graphs are generated with the assumption that the dc voltage into the buck converter is a constant 10 volts dc, and the load resistance is a constant 10 ohms.

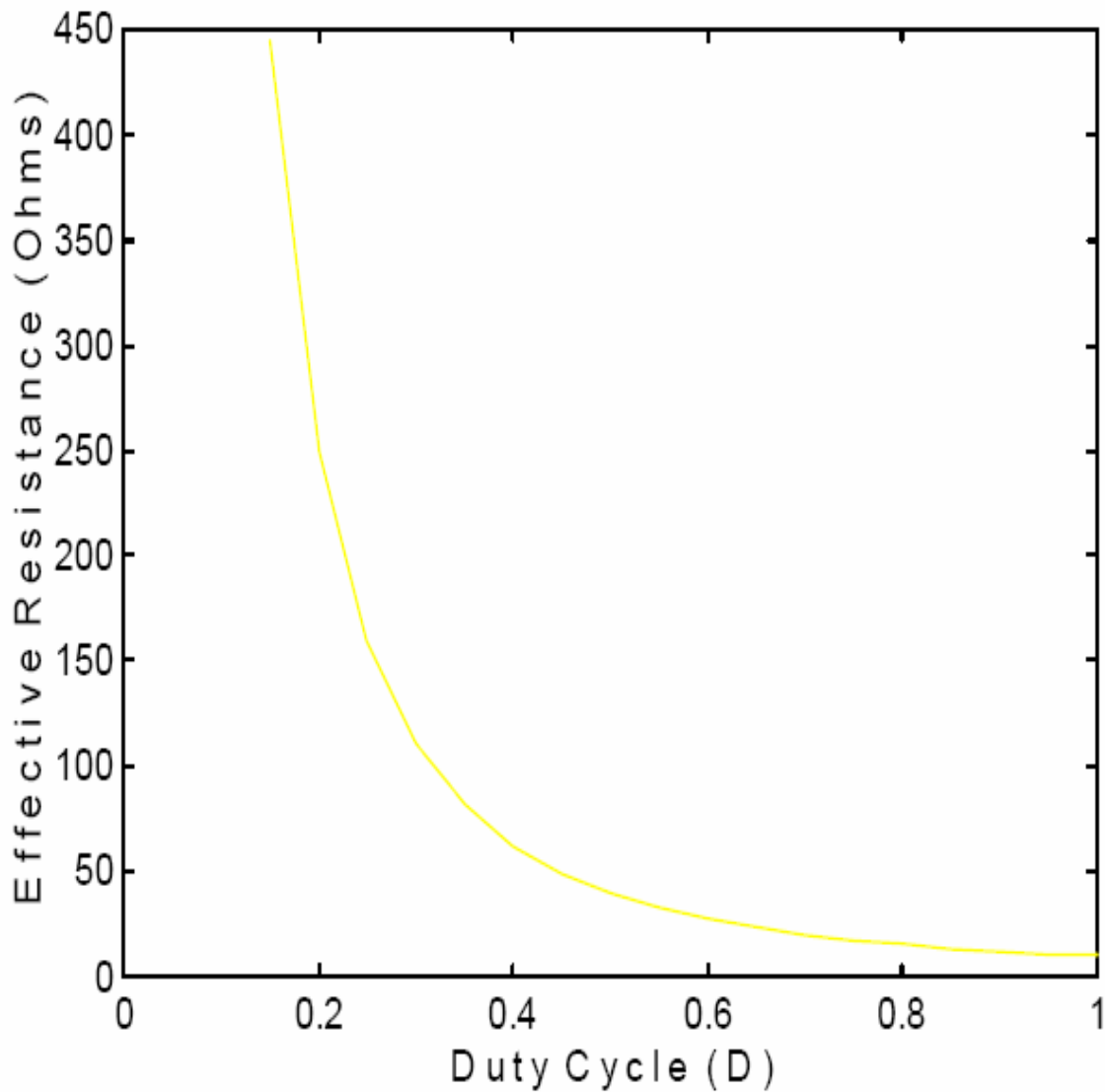

Figure 5.9. Effective resistance vs duty cycle for buck converter

Figure 5.9 displays how the effective resistance presented to the source decreases as the duty cycle increases. This trend is the same as that of the boost converter except for the fact that the buck effective resistance starts at an infinite resistance at a zero duty cycle and ends at the value of the load resistance, and the boost starts at the value of the load resistance and ends at a zero effective resistance.

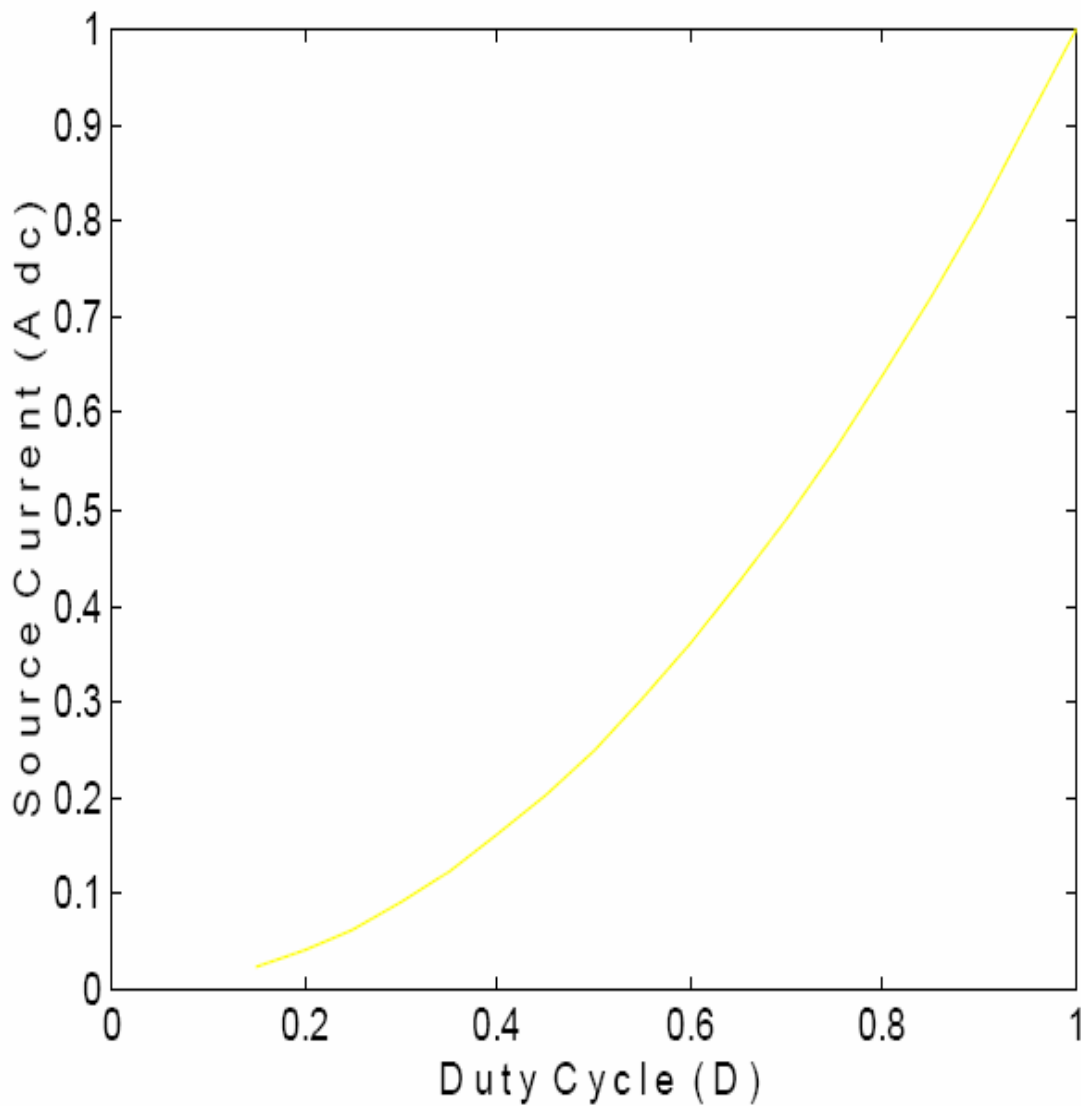

Figure 5.10. Source (input) current vs duty cycle for buck converter

Figure 5.10 shows how the source current increases as the duty cycle increases. At a duty cycle of zero the effective resistance is infinity and no current flows in the circuit. As the duty cycle increases, the source current increases exponentially, but only up a maximum value of V_{dc}/R_L .

Figure 5.11 shows how the rise of input power as the duty cycle is increased

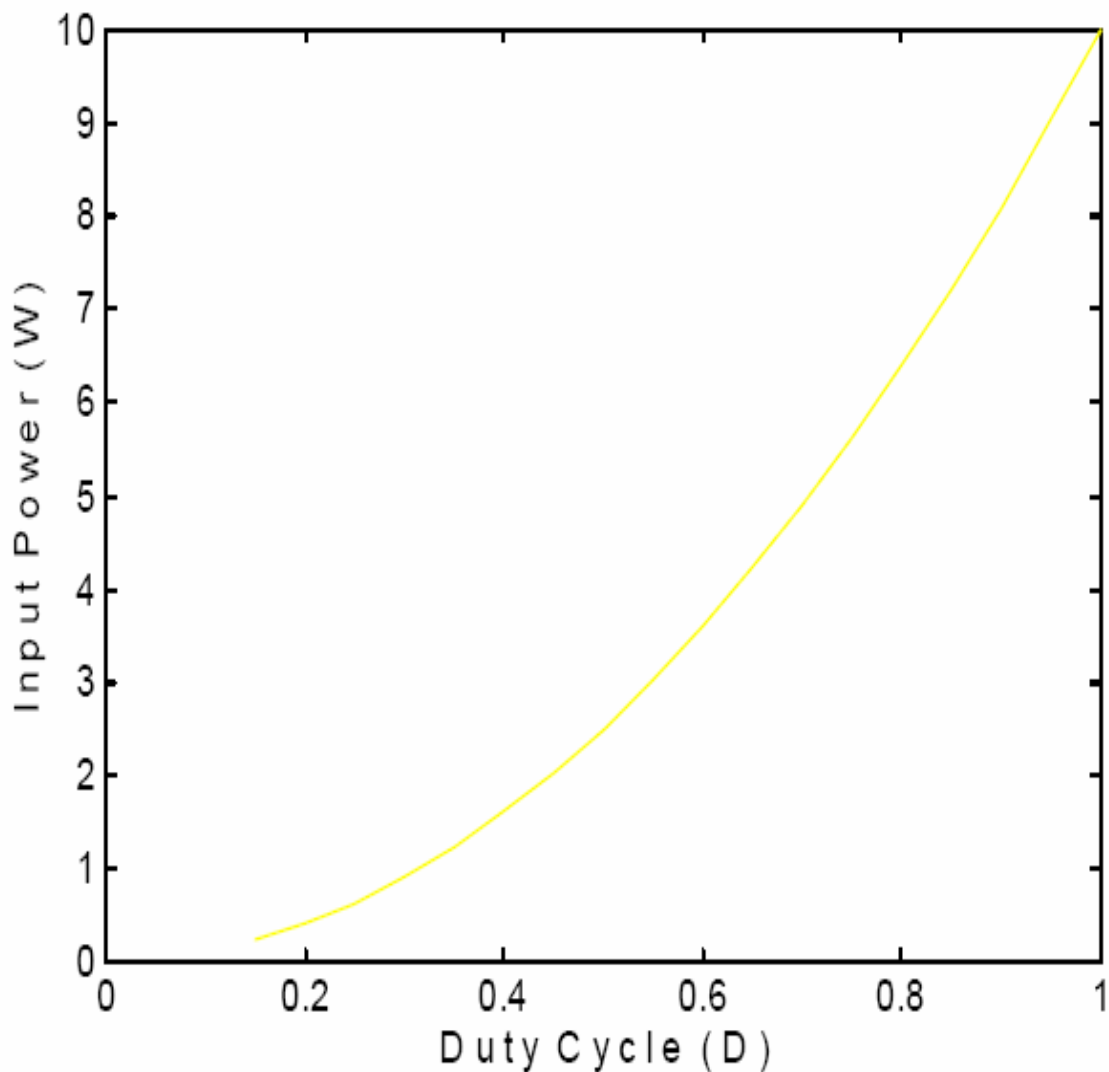

Figure 5.11 Input power vs duty cycle for buck converter.

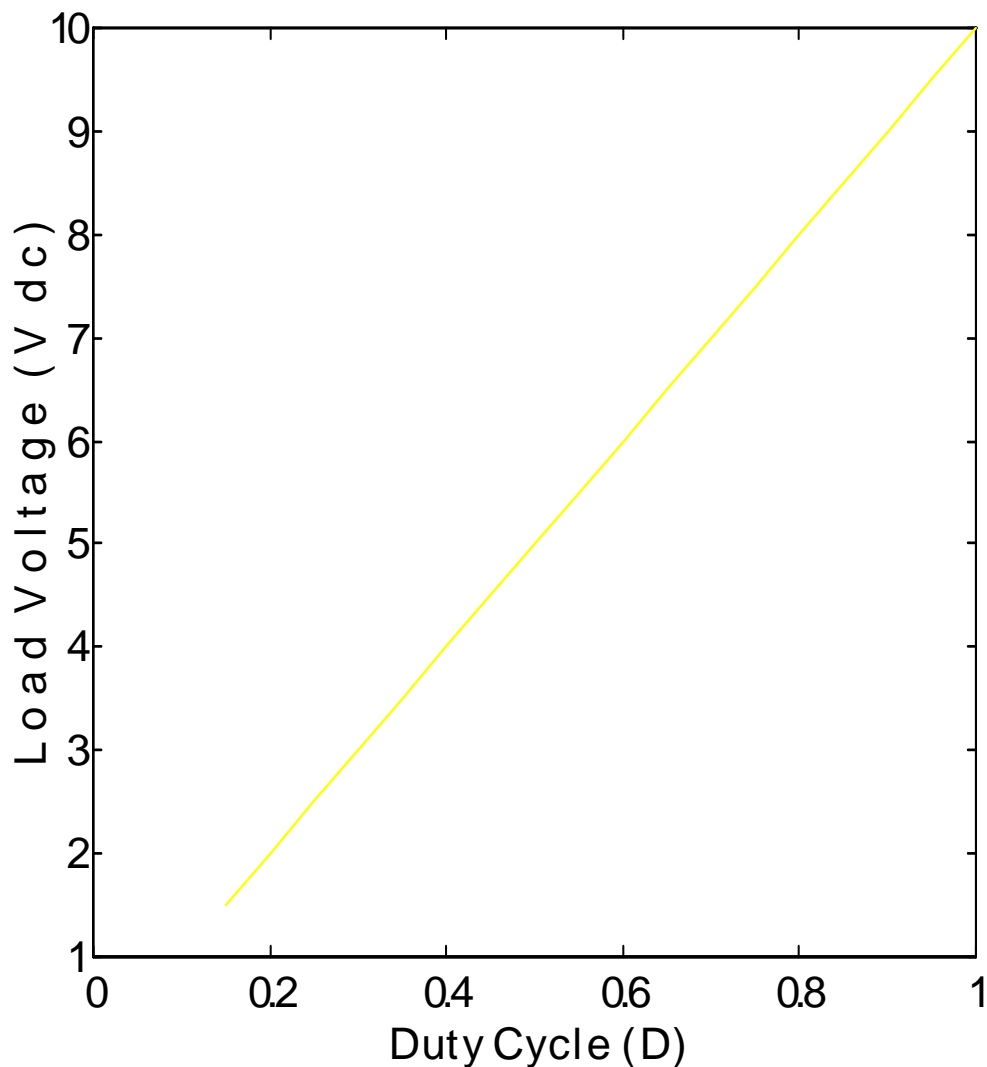

Figure 5.12. Load voltage vs duty cycle for buck converter

Figure 5.12 displays the intended effect of the buck converter topology. As the duty cycle is decreased, the load voltage becomes smaller than the source voltage. One point of interest is that unlike the boost converter (which, as will be seen in the next chapter, is a function of the duty cycle squared) the load voltage for the buck varies linearly with the duty cycle.

5.3 Steady State Performance of an IPM Generator Feeding a Rectifier-Buck-Resistive Load

5.3.1 Introduction

In this section, the measured steady state performance of the IPM generator feeding a rectifier-buck-resistive load will be compared with the predicted performance of the system.

In order to obtain a full performance curve (meaning that the performance of the IPM generator is tested for loads ranging from a light load to a large load) for the buck converter, it is not the load resistance R_L which is varied from a small to a large value. Rather, it is the duty cycle D which is varied from almost zero to 1.

Referring back to Figure 5.9, and remembering that the actual load resistance for this graph was 10 ohms, it can be seen that the smallest resistance which the generator will see is the actual load resistance R_L . Thus, if one wants to be able to study the buck system operating under a large load, a small load resistance must be chosen. As the duty cycle is decreased from 1, the effective resistance increases and, therefore, it is possible to test the topology under the condition when the IPM generator is feeding a small load.

The load resistance chosen to test the system was 2.5Ω and the system was tested for the operating frequencies of 30 and 45 Hz. The values of the rectifier filter components were $L_d = 9.3 \text{ mH}$ and $C_1 = 10 \text{ mF}$. The values of the buck filter were $L_p = 10 \text{ mH}$ and $C_o = 10 \text{ mF}$.

5.3.2 Experimental and Predicted Performance Results

Figure 5.13 shows how measured and calculated line to neutral voltage of the generator varies as a function of the power out of the generator. If the rectifier-buck system truly appeared as a purely resistive load to the IPM, then the measured results would fall almost exactly on the calculated results line as they did in Figure 3.5.

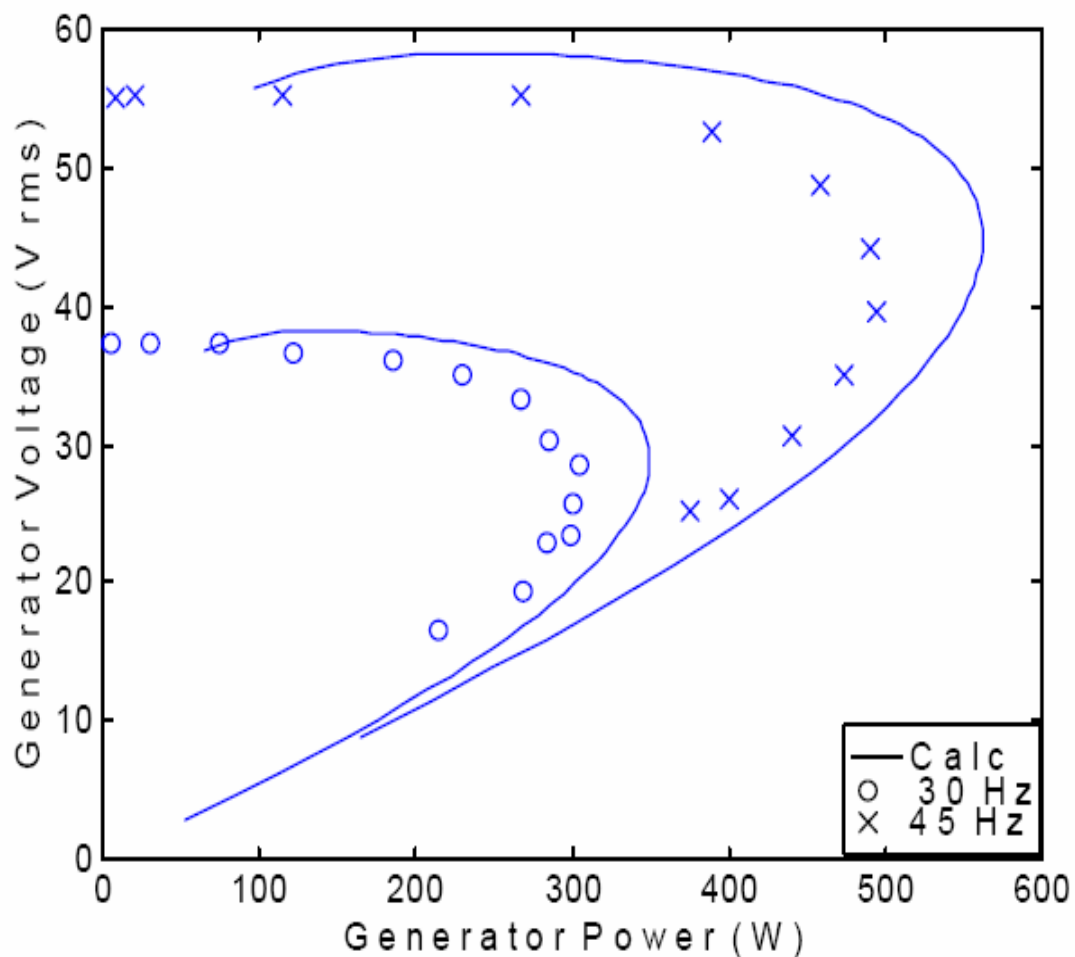

Figure 5.13. Measured and calculated generator line to neutral voltage vs generator output power for the IPM feeding a rectifier-buck-resistive load

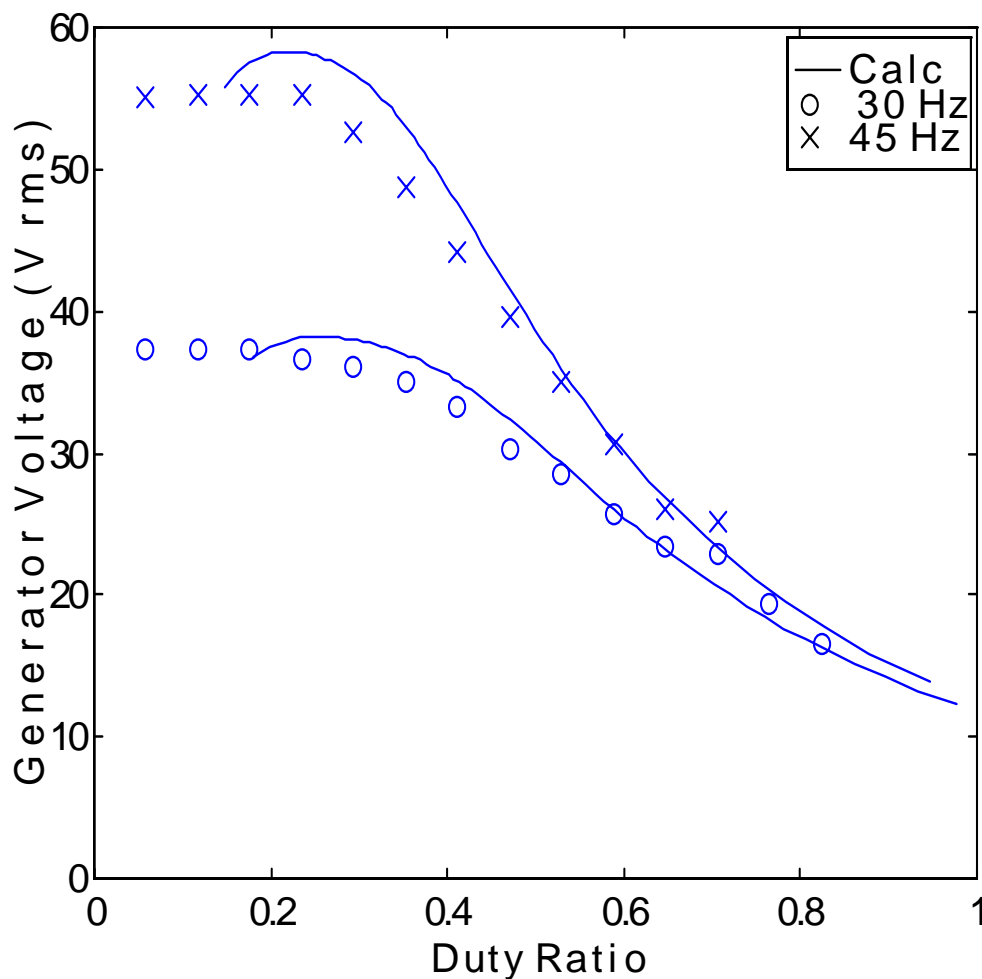

Figure 5.14. Measured and calculated generator line to neutral voltages vs duty ratio for the IPM feeding a rectifier-buck-resistive load

The graphs had shown in Figures 5.14 and 5.15 show how the measured and calculated generator and rectifier voltages vary as a function of the duty ratio. For the buck converter, when a very small duty ratio is given, a huge equivalent resistance is presented to the load (see Figure 5.9). It can be seen that the calculated model begins to fall sharply for

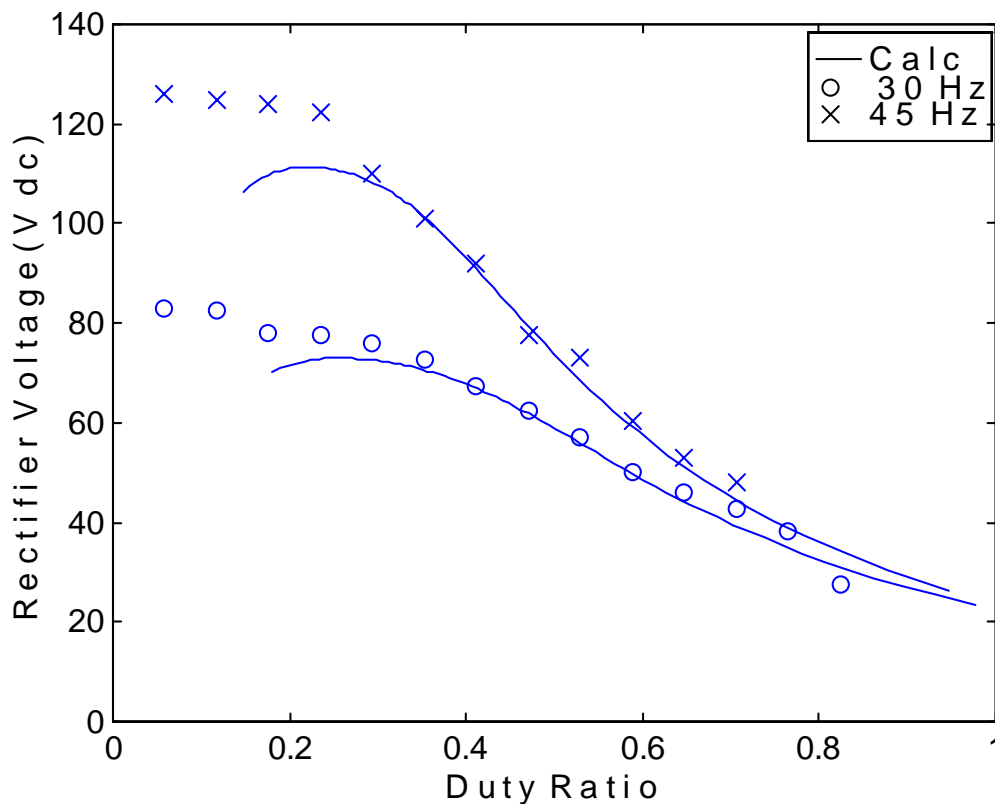

Figure 5.15. Measured and calculated rectifier voltage vs duty ratio for the IPM feeding a rectifier-buck-resistive load

the case of a very large equivalent resistance, but the actual measured generator and rectifier voltages do not show this trend. As has already been suggested, in order to get an improved model the IPM operating under a very light load, a finite element analysis to obtain the machines parameters under this condition would be beneficial. At a duty ratio of 1, Figure 5.14 shows that the generator voltage is still above 10 volts and thus the extremely heavy load condition was not obtained in this experiment. This observation is also helpful in realizing that the rectifier-buck converter topology could be operated over the full duty cycle

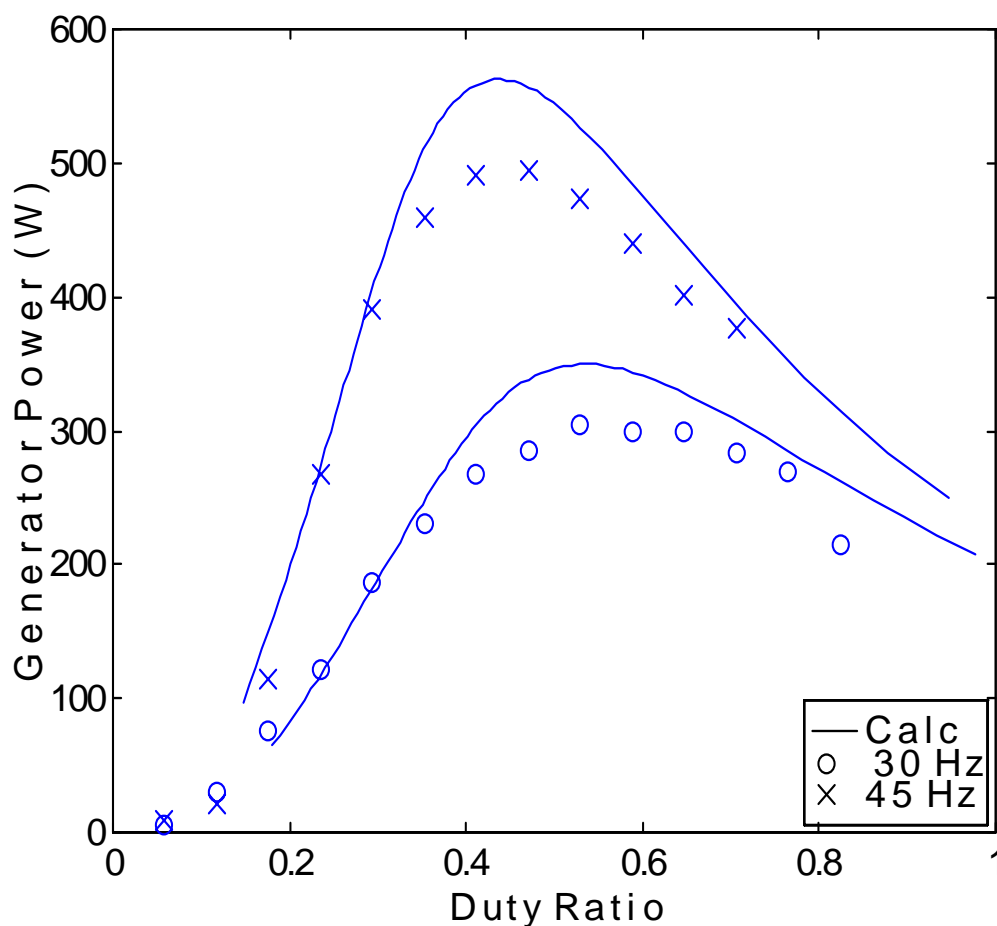

Figure 5.16. Measured and calculated rectifier voltage vs duty ratio for the IPM feeding a rectifier-buck-resistive load

(0-1) if the actual load resistance were large enough to keep the IPM generator from exceeding its maximum power point. The maximum frequency which the generator was operating would also have to be known since the resistance at the maximum power operating point increases as the operating frequency increases (see Figure 3.8).

Figure 5.16 shows the plot of the generators output power vs the duty ratio. At very low duty ratios, the very large equivalent resistance seen by the generator allows very little

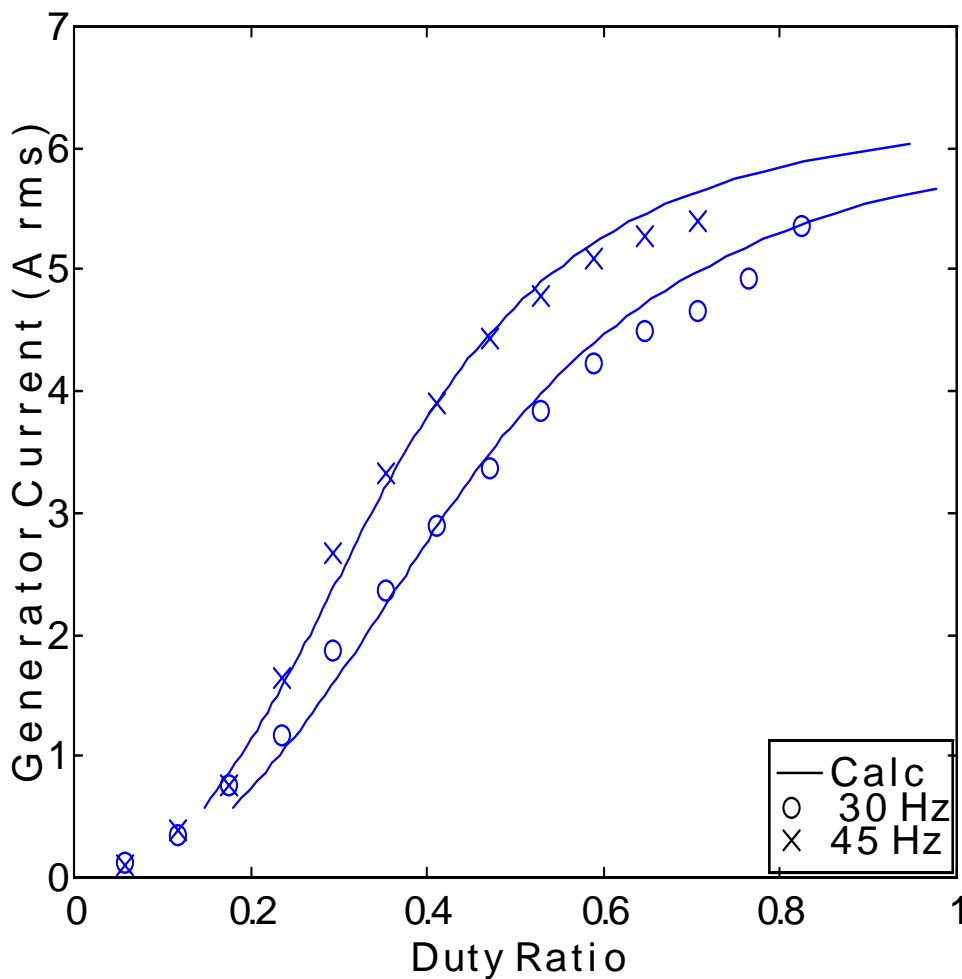

Figure 5.17. Measured and calculated generator current vs duty ratio for the IPM feeding rectifier-buck-resistive load

current to flow through the rectifier-buck topology. The power increases up to a duty ratio of approximately .45 for 45 Hz operation and .55 for 30 Hz operation.

Figure 5.17 shows how the generator current varies as the duty ratio is varied. The calculated generator current is very close to the actual measured current of the generator.

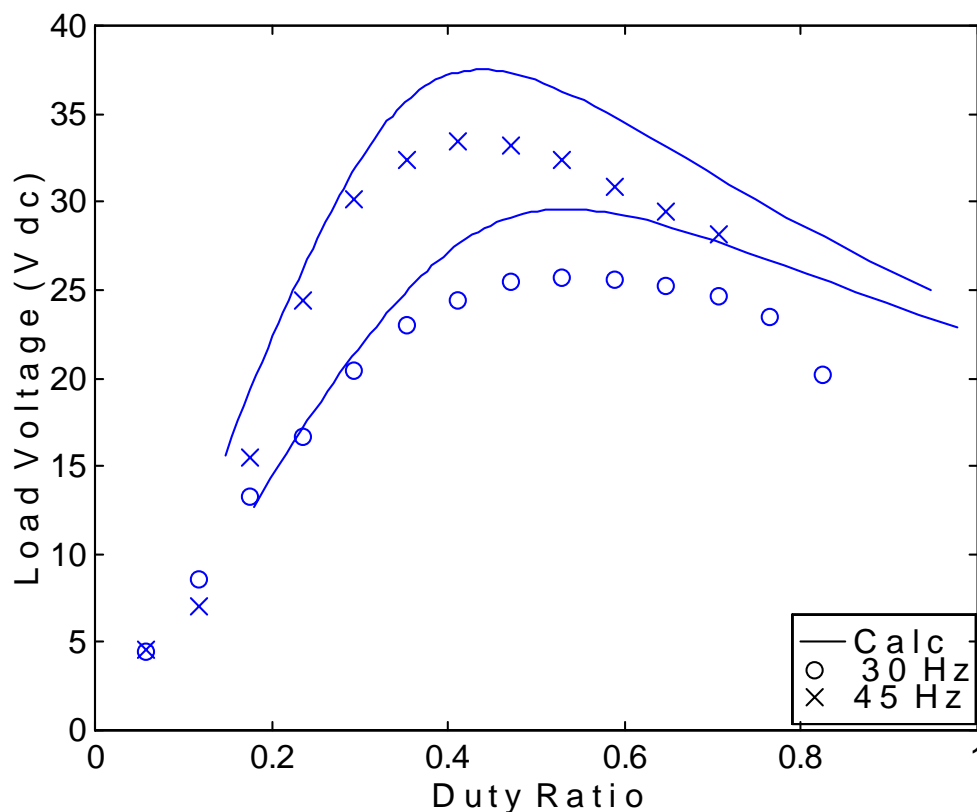

Figure 5.18. Measured and calculated load voltage vs duty ratio for the IPM feeding a rectifier-buck-resistive

The graph shown in Figure 5.18 shows how the load voltage varies as the duty ratio is changed. Remembering that the purpose of the buck converter is to decrease the load voltage as the duty cycle decreases (see Figure 5.12), it can be seen that this is only happening for a duty cycle below approximately 0.45 for the 45 Hertz operation and 0.55 for the 30 Hz operation. One could argue that the load voltage is also effectively decreased as the duty cycle increases beyond these two points, but in this region the generator currents are high and the efficiency is low. A graph showing the plot of the efficiency of the converter can be seen in Figure 5.19

Figure 5.20 shows the plot of the measured power loss of the rectifier-buck system. It can be seen that as the duty ratio increases, the power loss increases. This is true even beyond the duty ratios when the power into the system has begun to decrease.

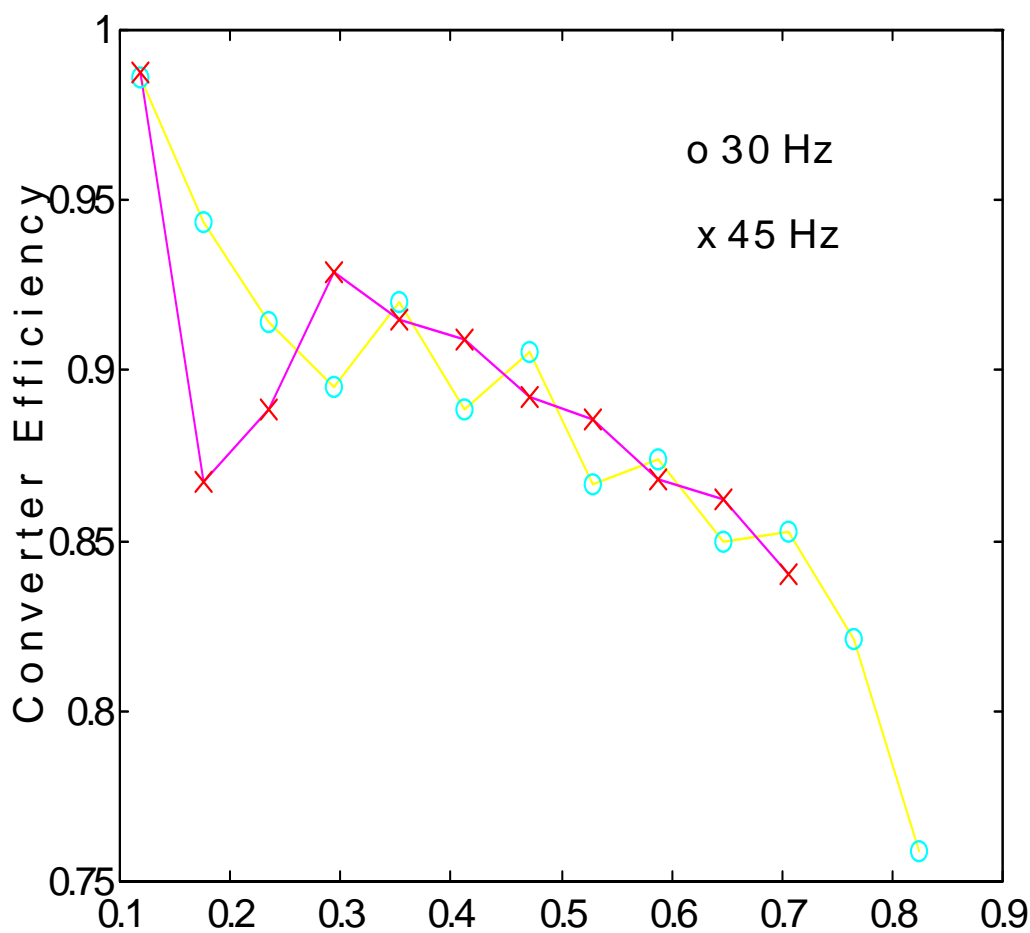

Figure 5.19. Plot of converter efficiency vs duty ratio for the IPM feeding a rectifier-buck resistive load topology

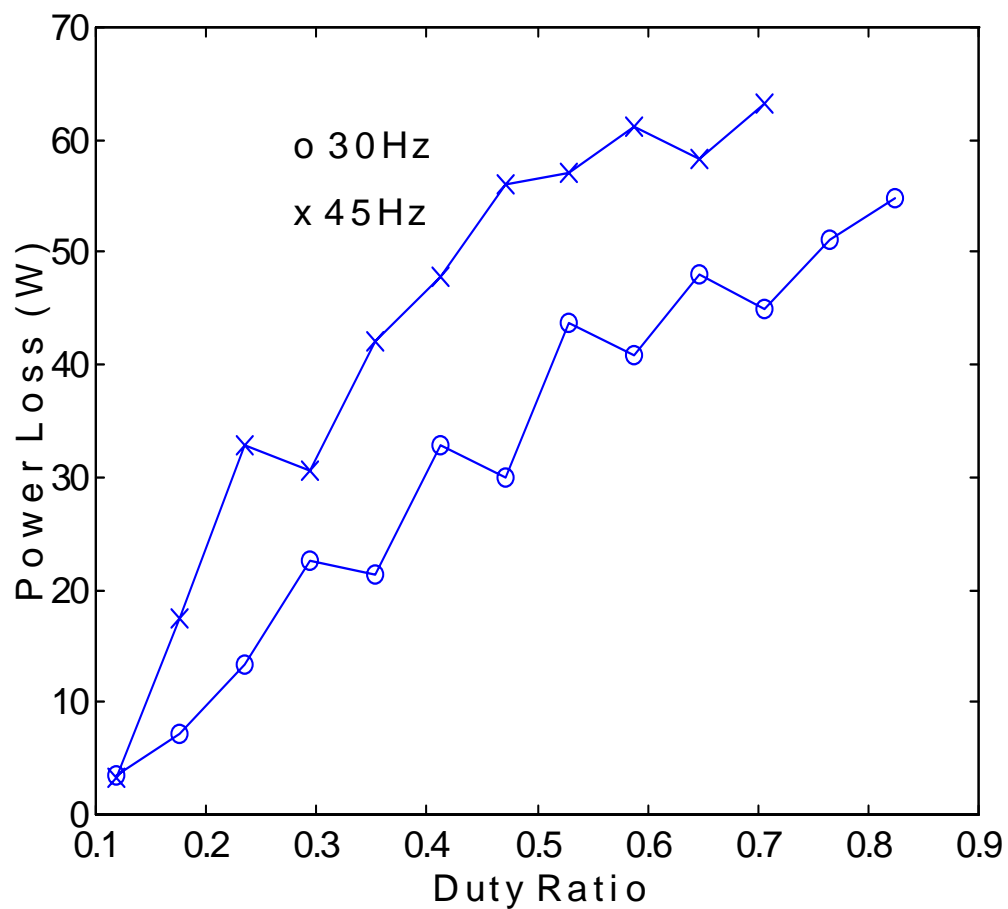

Figure 5.20. Measured power loss vs duty ratio for the IPM feeding a rectifier-buck-resistive load

5.4 Modeling of the Transistor

The modeling of a transistor in Simulink is similar to the model of the diode, except that the time the switch is on and the time in which the switch is off is controlled externally, and is not dependent on the voltage across or the current through the device. Figure 5.21 shows the Simulink block diagram of a UI transistor. In order for the transistor switch to be closed, the voltage across the transistor V_{ce} must be positive, and the control signal V_b must be above some threshold. For the example given in Figure 5.21, the threshold for V_b is .5 volts. Employing the same method of using a high gain to convert a UI diode into an IU diode, Figure 5.22 shows the Simulink model of an IU transistor. The Simulink symbolic representations of the UI and IU transistors are shown in Figures 5.23(a) and 5.23(b).

As has already been discussed in the introduction of this chapter, the method used in this thesis to control the switching was to compare the waveforms of a triangle wave with that of a dc signal. Figure 5.24(a) shows the triangle and dc waveforms superimposed on one another. The magnitude of the dc signal divided by the peak value of the triangular signal is referred to as the duty cycle (or duty ratio). For the example shown, the duty cycle is 0.8. When the dc signal is larger than the triangle wave, a signal large enough to overcome the bias voltage is sent to the transistor to turn it on. When the dc signal is smaller than the triangle wave, the signal to the transistor is turned off and, thus, the transistor is turned off. The resulting signal sent to the transistor is shown in Figure 5.24(b). Thus, the amount of time which the transistor is on can be controlled by the magnitude of the dc signal. For a duty cycle of 1, the transistor is always on.

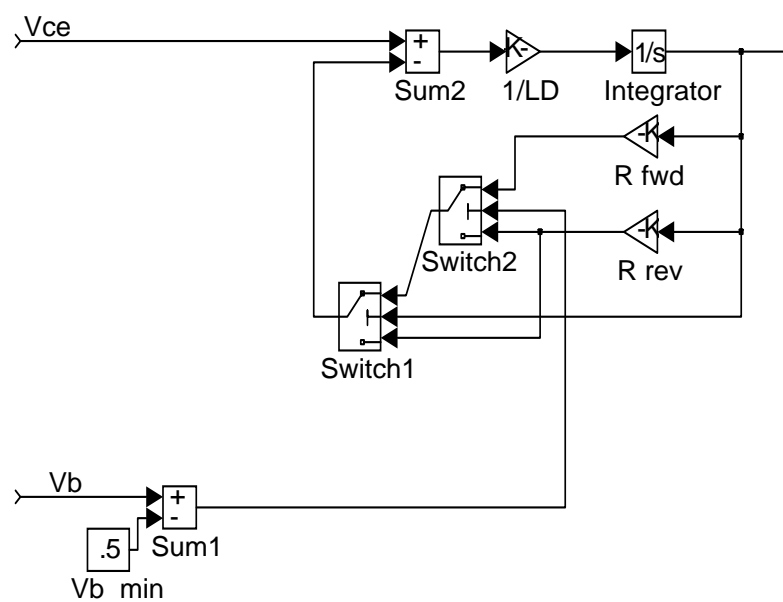

Figure 5.21. Simulink model of a UI transistor

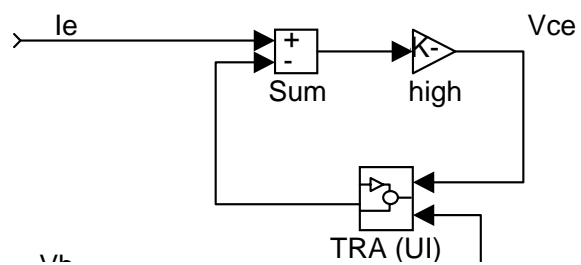

Figure 5.22. Simulink model of an IU transistor

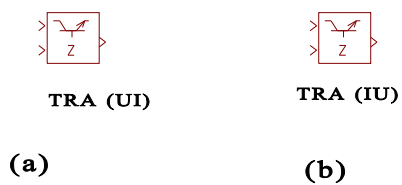

Figure 5.23. Simulink symbolic representation of (a) a UI transistor and (b) an IU transistor

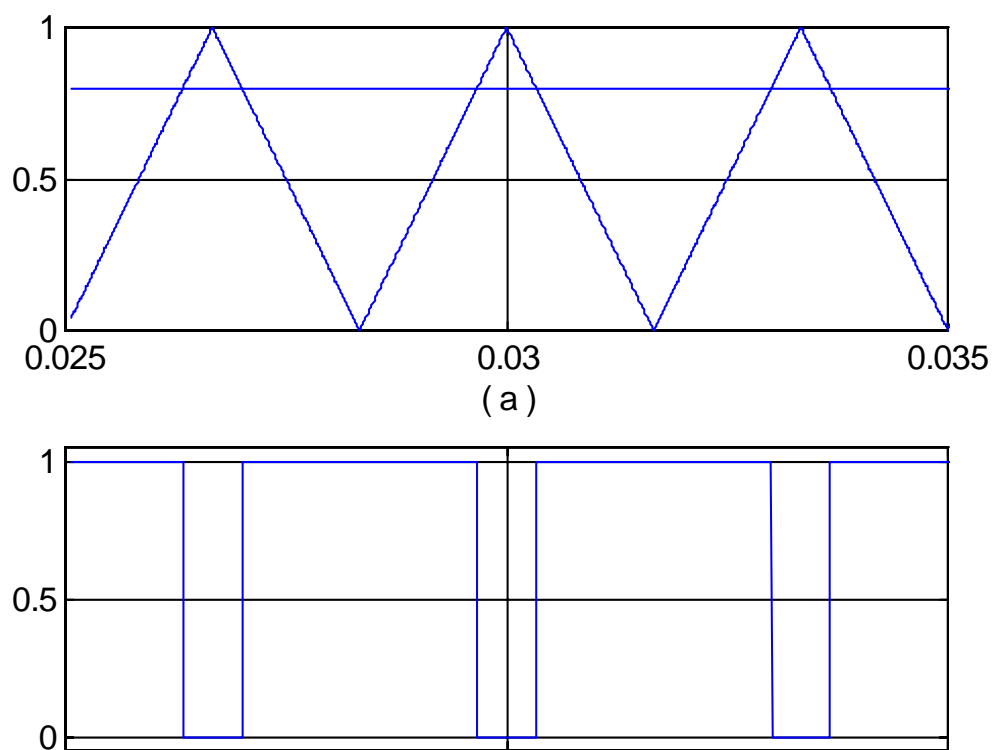

Figure 5.24. Generation of switching scheme for transistor. (a) a dc signal superimposed upon a triangle wave, (b) signal sent to a transistor

5.5 Comparison of Measured and Simulated Waveforms of IPM Machine Feeding a Rectifier- Buck-Resistive Load

This section includes the comparison between simulation and measured waveforms for the IPM generator feeding a rectifier-buck-resistive load. Two cases will be looked at. The first is when the buck converter is operating in continuous conduction mode, and the second is when the converter is operating in discontinuous conduction mode.

5.5.1 Buck Converter in Continuous Conduction Mode

This section looks at measured and simulated waveforms when the IPM is feeding a rectifier-buck-resistive load topology for the case when the buck is operating in continuous conduction mode. The frequency of operation of the IPM machine is 30 Hz. The rectifier filter inductor and capacitor values are $L_d=10\text{mH}$ and $C_1 = 5.6\mu\text{F}$, the buck filter inductor and capacitor values are $L_p=10\text{mH}$ and $C_o=5.8\mu\text{F}$, and the load resistance value is $R_L = 10\Omega$. The duty cycle was set at .83.

Figures 5.25 and 5.26 show the simulated and measured line to line voltage and line current waveforms of the IPM generator. The comparison between the simulated and measured waveforms is favorable.

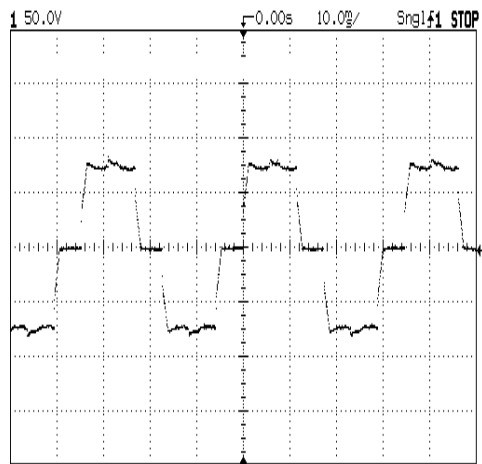

Measurement

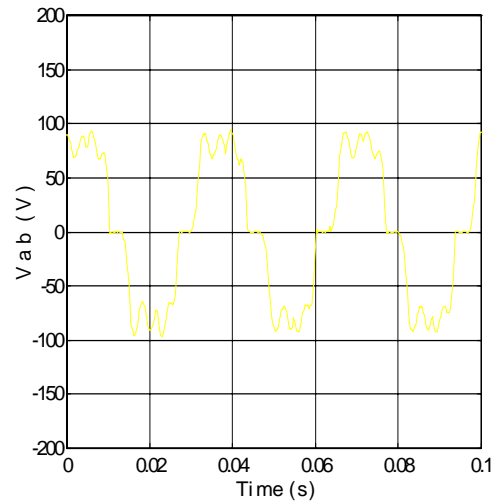

Simulation

Figure 5.25. Measured and simulated line to line voltage waveforms for the generator feeding a rectifier-buck-resistive 10Ω resistive load. Rotor speed=900 rpm. Measured waveform scale: voltage: 50v/div, time 10ms/div

Figure 5.27 shows the measured and simulated current in the inductor L_p . It can be seen from the figure that, similar to the current I_p depicted in Figure 5.5, the current rises almost linearly when the transistor is turned on and falls linearly when the transistor is turned off; however, unlike the current in Figure 5.5, measured and simulated currents never become equal to zero. In other words, since the current I_p always has a positive value, the converter is operating in continuous conduction mode. Figure 5.28 shows the measured and simulated current through the transistor T1.

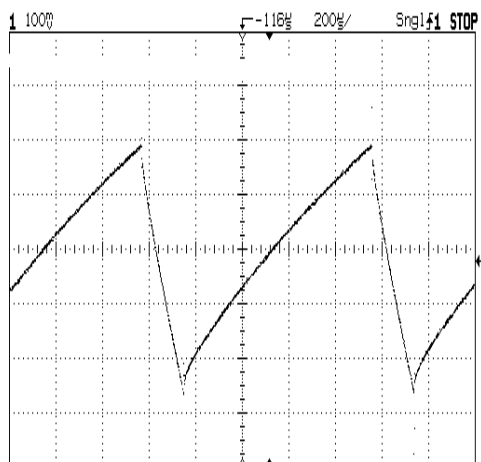

Measurement

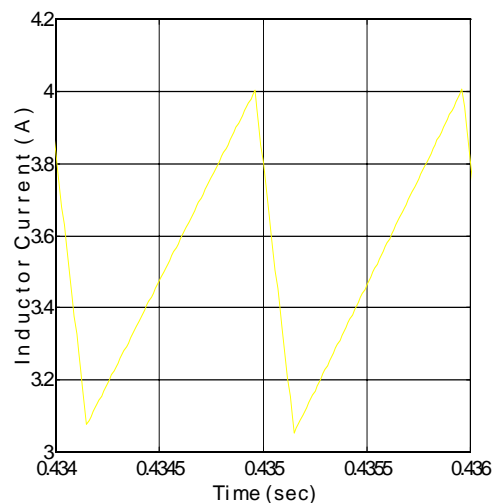

Simulation

Figure 5.26. Measured and simulated generator current waveforms for the generator feeding a rectifier-buck-resistive 10Ω resistive load. Rotor speed=900 rpm. Measured waveform scale: current: 1A/div, time 5ms/div

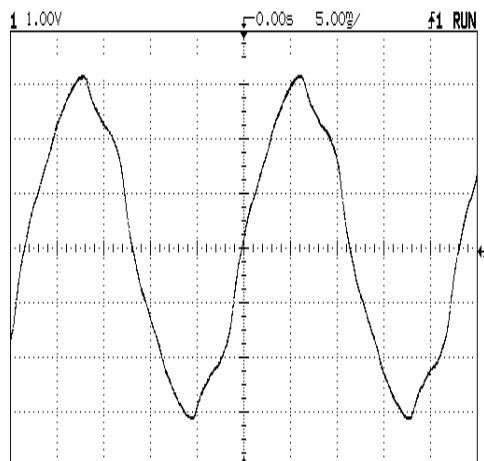

Measurement

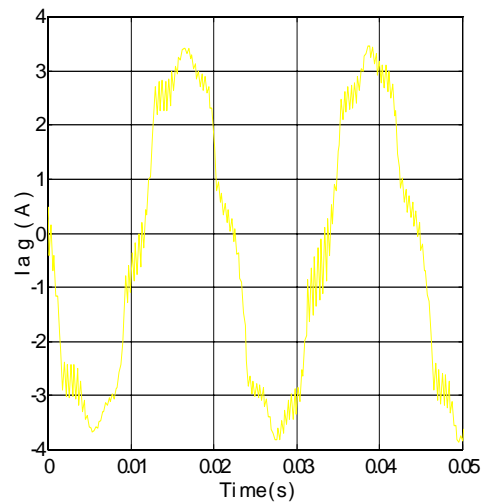

Simulation

Figure 5.27. Measured and simulated buck inductor current waveforms for the generator feeding a rectifier-buck-resistive 10Ω resistive load. Rotor speed=900 rpm. Measured waveform scale: current: .1A/div, time .2ms/div

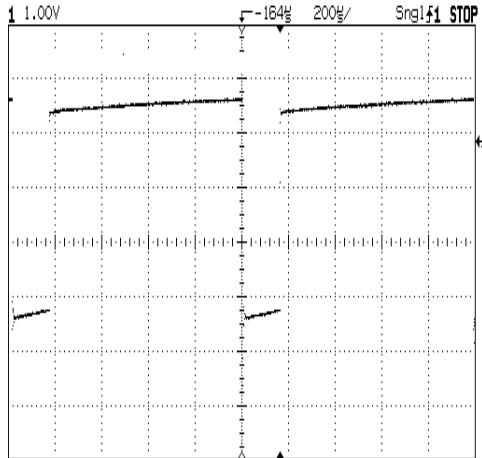

Measurement

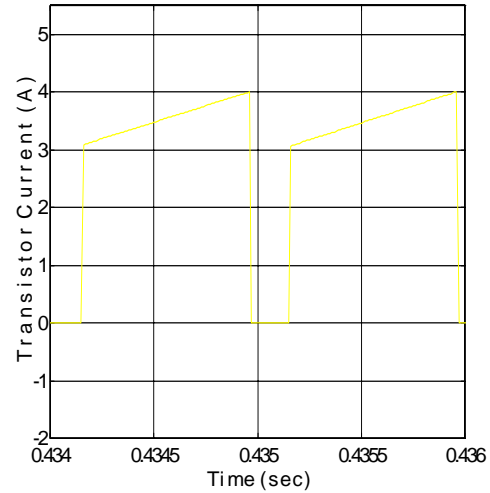

Simulation

Figure 5.28. Measured and simulated buck transistor current waveforms for the generator feeding a rectifier-buck-resistive 10Ω resistive load. Rotor speed=900 rpm. Measured waveform scale: current: 1A/div, time .2ms/div

5.5.2 Buck Converter in Discontinuous Conduction Mode

In this section, the inductor L_p is changed from the value of 10mH used in section 5.42 to the value of .25mH. In addition, the duty cycle is changed from .83 to a value of .2. With these changes, the buck converter no longer operates in continuous conduction mode; rather, it operates in discontinuous conduction mode.

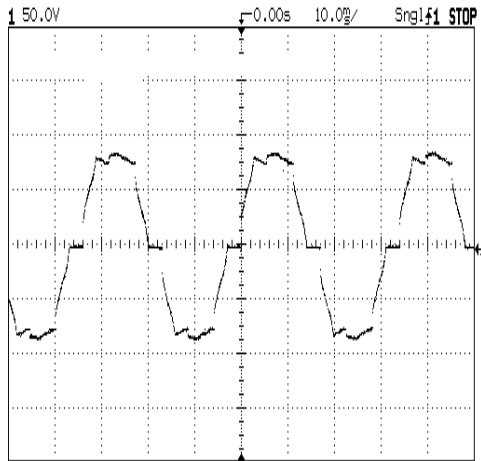

Measurement

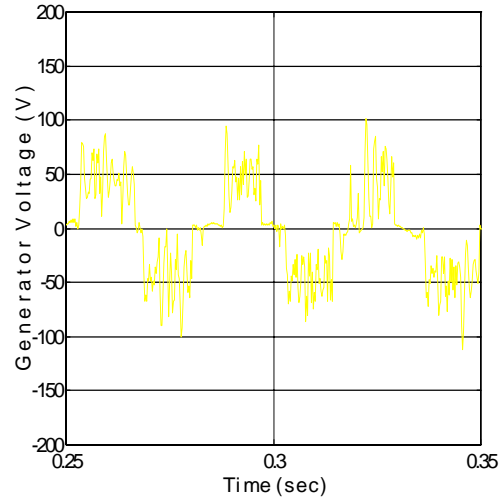

Simulation

Figure 5.29. Measured and simulated generator line to line voltage waveforms for the generator feeding a rectifier-buck-resistive 10Ω resistive load. Rotor speed=900 rpm. Measured waveform scale: voltage: 50v/div, time 2ms/div

Figures 5.29 and 5.30 show the measured and simulated line to line voltage and line current of the generator. The simulated voltage waveform shows a much higher degree of harmonic distortion than the actual measured waveform exhibits. It is believed that the reason for this is that, since the low duty cycle chosen makes the effective resistance which the generator sees very high, and, as has been shown for the case of the rectifier, the simulation model does not perform as well when the generator is operating under light load.

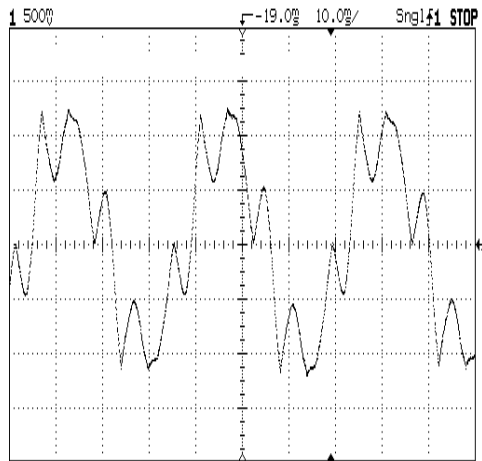

Measurement

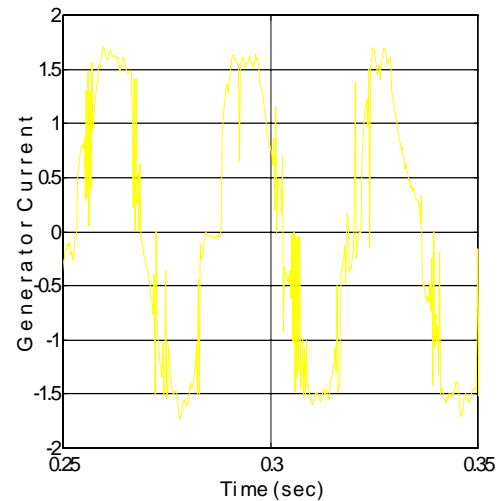

Simulation

Figure 5.30. Measured and simulated generator line current waveforms for the generator feeding a rectifier-buck-resistive 10Ω resistive load. Rotor speed=900 rpm. Measured waveform scale: current: $.5A/div$, time $2ms/div$

It can be seen in Figure 5.31 that the converter is clearly operating in discontinuous conduction mode. It is also worthwhile to note the difference in the current in the measured waveform of Figures 5.31 and 5.32 (where the converter is in discontinuous mode) to the measured inductor and transistor currents of Figures 5.27 and 5.28. When the converter is in discontinuous mode it can be seen that both the peak current and the change in current from its minimum to maximum value is much larger than when the converter is operating in continuous conduction mode. The high stresses placed on the transistors due to the large currents and large rate of change in currents (di/dt) is one of the main reasons why, for practical designs, the discontinuous mode of operation is normally avoided.

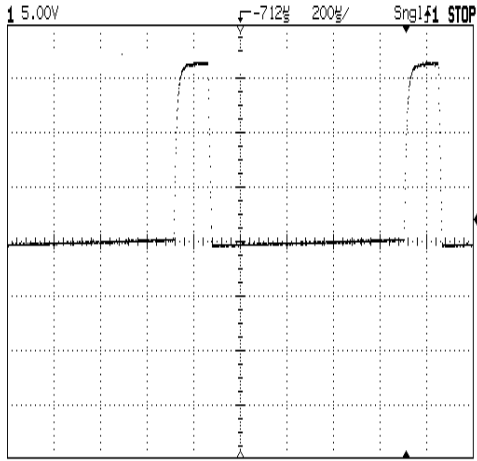

Measurement

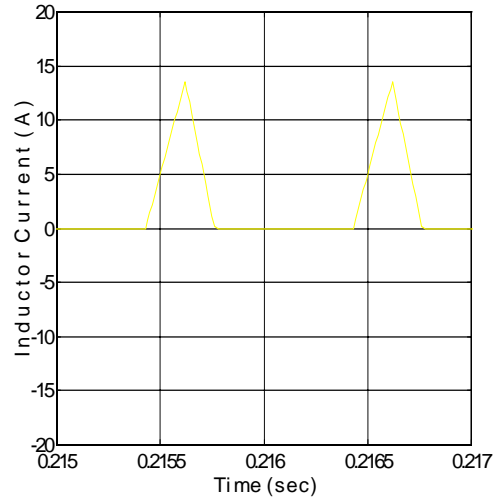

Simulation

Figure 5.31. Measured and simulated inductor current waveforms for the generator feeding a rectifier-buck-resistive 10Ω resistive load. Rotor speed=900 rpm. Measured waveform scale: current: 5A/div, time .2ms/div

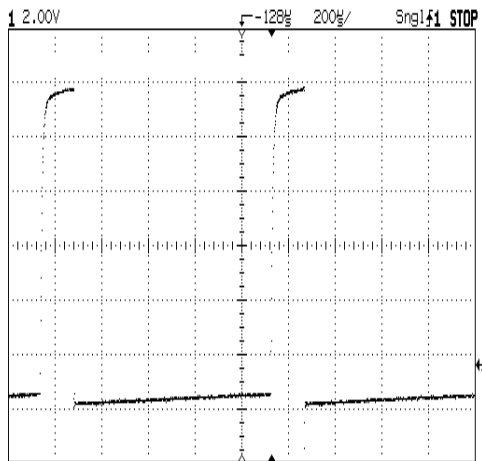

Measurement

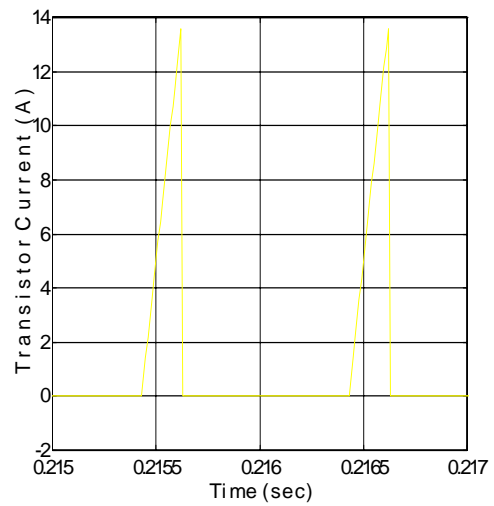

Simulation

Figure 5.32. Measured and simulated transistor current waveforms for the generator feeding a rectifier-buck-resistive 10Ω resistive load. Rotor speed=900 rpm. Measured waveform scale: current: 2A/div, time .2ms/div